

V1.00.000

12-19-2018

Trademark Information

ANCEL[®] is a registered trademark of OBDSpace TECHNOLOGY CO., LTD. (ANCEL) in China and other countries. All other ANCEL trademarks, service marks, domain names, logos and company names referred to in this manual are either trademarks, registered trademarks, service marks, domain names, logos and company names of or are otherwise the property of ANCEL or its affiliates. In countries where any of the ANCEL trademarks, service marks, domain names, logos and company names are not registered, ANCEL claims other rights associated with unregistered trademarks, service marks, domain names, logos and company names. Other products or company names referred to in this manual may be trademarks of their respective owners. You may not use any trademark, service mark, domain name, logo, or company name of ANCEL or any third party without permission from the owner of the applicable trademark, service mark, domain name, logo, or company name. You may contact ANCEL at www.anceldirect.com, or write to OBDSpace TECHNOLOGY CO., LTD., Runfeng Office, Longhua District, Shenzhen, Guangdong, 518000, P. R. China, to request written permission to use Materials on this manual for purposes or for all other questions relating to this manual.

Copyright Information

Copyright © 2019 by OBDSpace TECHNOLOGY CO., LTD. All rights reserved. No part of this publication may be reproduced, stored in a retrieval system, or transmitted in any form or by any means, electronic, mechanical, photocopying and recording or otherwise, without the prior written permission of ANCEL. The information contained herein is designed only for the use of this unit. ANCEL is not responsible for any use of this information as applied to other units.

General Notice

- Other product names used herein are for identification purposes only and may be trademarks of their respective owners. ANCEL disclaims any and all rights in those marks.
- There is a possibility that this unit is inapplicable to some of the vehicle models or systems listed in the diagnosis section due to different countries, areas, and/or years. Do not hesitate to contact ANCEL if you come across such questions. We are to help you solve the problem as soon as possible.

Disclaimer

- To take full advantage of the unit, you should be familiar with the engine.
- All information, illustrations, and specifications contained in this manual are based on the latest information available at the time of publication. The right is reserved to make change at any time without notice.
- Neither ANCEL nor its affiliates shall be liable to the purchaser of this unit or third parties for damages, losses, costs or expenses incurred by purchaser or third parties as a result of: accident, misuse, or abuse of this unit, or unauthorized modifications, repairs, or alterations to this unit, or failure to strictly comply with ANCEL operating and maintenance instructions.
- ANCEL shall not be liable for any damages or problems arising from the use of any options or any consumable products other than those designated as Original ANCEL Products or ANCEL Approved Products by ANCEL.

Safety Precautions and Warnings

To prevent personal injury or damage to vehicles and/or the FX2000, please read this user's manual first carefully and observe the following safety precautions at a minimum whenever working on a vehicle:

- Always perform automotive testing in a safe environment.
- Do not attempt to operate or observe the tool while driving a vehicle. Operating or observing the tool will cause driver distraction and could cause a fatal accident.
- Wear safety eye protection that meets ANSI standards.
- Keep clothing, hair, hands, tools, test equipment, etc. away from all moving or hot engine parts.
- Operate the vehicle in a well-ventilated work area: Exhaust gases are poisonous.
- Put blocks in front of the drive wheels and never leave the vehicle unattended while running tests.
- Use extreme caution when working around the ignition coil, distributor cap, ignition wires and spark plugs. These components create hazardous voltages when the engine is running.

- Put the transmission in P (for A/T) or N (for M/T) and make sure the parking brake is engaged.
- Keep a fire extinguisher suitable for gasoline/chemical/ electrical fires nearby.
- Don't connect or disconnect any test equipment while the ignition is on or the engine is running.
- Keep the FX2000 dry, clean, free from oil/water or grease. Use a mild detergent on a clean cloth to clean the outside of the FX2000, when necessary.

Table of Contents

1. Introduction	1
2. General Information	1
2.1 On-Board Diagnostics (OBD) II	1
2.2 Diagnostic Trouble Codes (DTCs).....	2
2.3 Location of the Data Link Connector (DLC).....	2
2.4 OBD II Readiness Monitors	3
2.5 OBD II Monitor Readiness Status.....	4
2.6 OBD II Definitions	4
3. Product Descriptions	6
3.1 Outline of FX2000.....	6
3.2 Specifications	7
3.3 Accessories Included.....	7
4. Connection	8
4.1 Install memory card	8
4.2 Connect FX2000.....	8
4.3 Settings.....	9
5. Diagnose	10
5.1 OBDII/EOBD Diagnosing.....	10
5.2 System Diagnosing.....	13
5.3 Review.....	14
6. Help	15
6.1 DLC Location Information.....	15
6.2 DTC Library	15
6.3 Abbreviation.....	16
6.4 Tool Information	16
6.5 About OBD.....	16
6.6 Upgrade Information.....	16
7. Register & Update	17
8. FAQ	21

1. Introduction

The FX2000 are specially developed by ANCEL, which supports all 10 modes of OBD II test for a complete diagnosis. Featuring the 3.5" TFT color display, it enables users to read/clear DTCs, record, save and playback data in live graphic display. The FX2000 Series are also very easy to use. With built-in help menus and code definitions, diagnosing and repairing that dreaded Check Engine Light is now easier than ever!

Moreover, FX2000 also feature the following bi-directional "special tests": EVAP, O2 Sensor, I/M Readiness, MIL Status, VIN Info, and On-board monitors testing. It can be connected to PC through the USB cable for upgrade to keep updated with the latest software version.

Notice: FX2000 may automatically reset while being disturbed by strong static electricity. THIS IS A NORMAL REACTION.

2. General Information

2.1 On-Board Diagnostics (OBD) II

The first generation of On-Board Diagnostics (OBD I) was developed by the California Air Resources Board (ARB) and implemented in 1988 to monitor some of the emission control components on vehicles. As technology evolved and the desire to improve the On-Board Diagnostic system increased, a new generation of On-Board Diagnostic system was developed. This second generation of On-Board Diagnostic regulations is called "OBD II".

The OBD II system is designed to monitor emission control systems and key engine components by performing either continuous or periodic tests of specific components and vehicle conditions. When a problem is detected, the OBD II system turns on a warning lamp (MIL) on the vehicle instrument panel to alert the driver typically by the phrase of "Check Engine" or "Service Engine Soon". The system will also store important information about the detected malfunction so that a technician can accurately find and fix the problem. Here below follow three pieces of such valuable information:

- 1) Whether the Malfunction Indicator Light (MIL) is commanded 'on' or 'off';
- 2) Which, if any, Diagnostic Trouble Codes (DTCs) are stored;
- 3) Readiness Monitor status.

2.2 Diagnostic Trouble Codes (DTCs)

OBD II Diagnostic Trouble Codes are codes that are stored by the on-board

computer diagnostic system in response to a problem found in the vehicle. These codes identify a particular problem area and are intended to provide you with a guide as to where a fault might be occurring within a vehicle. OBD II Diagnostic Trouble Codes consist of a five-digit alphanumeric code. The first character, a letter, identifies which control system sets the code. The second character, a number, 0-3; other three characters, a hex character, 0-9 or A-F provide additional information on where the DTC originated and the operating conditions that caused it to set. Here below is an example to illustrate the structure of the digits:

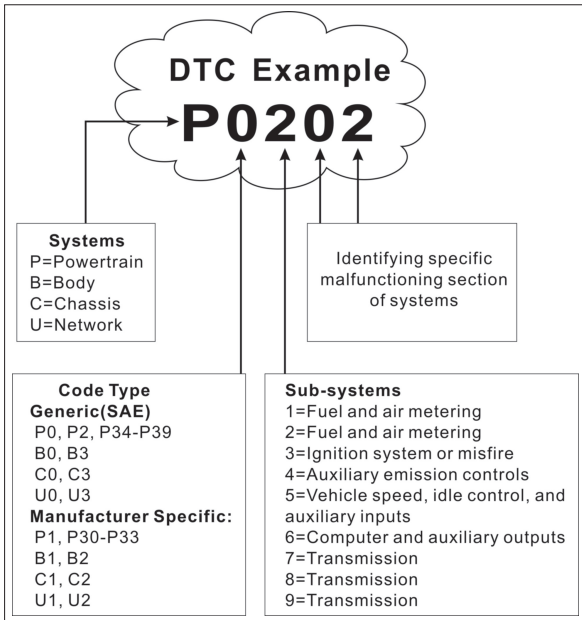

Figure 2-1

2.3 Location of the Data Link Connector (DLC)

The DLC (Data Link Connector or Diagnostic Link Connector) is typically a 16-pin connector where diagnostic code readers interface with the vehicle's on-board computer. The DLC is usually located 12 inches from the center of the instrument panel (dash), under or around the driver's side for most vehicles. If Data Link Connector is not located under dashboard, a label should be there

telling location. For some Asian and European vehicles, the DLC is located behind the ashtray and the ashtray must be removed to access the connector. If the DLC cannot be found, refer to the vehicle's service manual for the location.

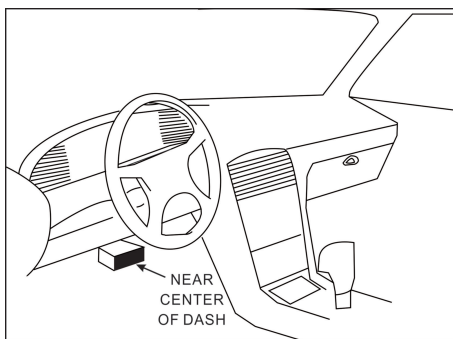

Figure 2-2

2.4 OBD II Readiness Monitors

An important part of a vehicle's OBD II system is the Readiness Monitors, which are indicators used to find out if all of the emissions components have been evaluated by the OBD II system. They are running periodic tests on specific systems and components to ensure that they are performing within allowable limits.

Currently, there are eleven OBD II Readiness Monitors (or I/M Monitors) defined by the U.S. Environmental Protection Agency (EPA). Not all monitors are supported in every vehicles and the exact number of monitors in any vehicle depends on the motor vehicle manufacturer's emissions control strategy.

Continuous Monitors -- Some of the vehicle components or systems are continuously tested by the vehicle's OBD II system, while others are tested only under specific vehicle operating conditions. The continuously monitored components listed below are always ready:

1. Misfire
2. Fuel System
3. Comprehensive Components (CCM)

Once the vehicle is running, the OBD II system is continuously checking the above components, monitoring key engine sensors, watching for engine misfire, and monitoring fuel demands.

Non-Continuous Monitors -- Unlike the continuous monitors, many emissions

and engine system components require the vehicle to be operated under specific conditions before the monitor is ready. These monitors are termed non-continuous monitors and are listed below:

- 1) EGR System
- 2) O2 Sensors
- 3) Catalyst
- 4) Evaporative System
- 5) O2 Sensor Heater
- 6) Secondary air Injection
- 7) Heated Catalyst
- 8) A/C system

2.5 OBD II Monitor Readiness Status

OBD II systems must indicate whether or not the vehicle's PCM's monitor system has completed testing on each component. Components that have been tested will be reported as "Ready", or "Complete", meaning they have been tested by the OBD II system. The purpose of recording readiness status is to allow inspectors to determine if the vehicle's OBD II system has tested all the components and/or systems.

The Powertrain Control Module (PCM) sets a monitor to "Ready" or "Complete" after an appropriate drive cycle has been performed. The drive cycle that enables a monitor and sets readiness codes to "Ready" varies for each individual monitor. Once a monitor is set as "Ready" or "Complete", it will remain in this state. A number of factors, including erasing of Diagnostic Trouble Codes (DTCs) with a code reader or a disconnected battery, can result in Readiness Monitors being set to "Not Ready". Since the three continuous monitors are constantly evaluating, they will be reported as "Ready" all of the time. If testing of a particular supported non-continuous monitor has not been completed, the monitor status will be reported as "Not Complete" or "Not Ready."

In order for the OBD monitor system to become ready, the vehicle should be driven under a variety of normal operating conditions. These operating conditions may include a mix of highway driving and stop and go, city type driving, and at least one overnight-off period. For specific information on getting your vehicle's OBD monitor system ready, please consult your vehicle owner's manual.

2.6 OBD II Definitions

Powertrain Control Module (PCM) -- OBD II terminology for the on-board computer that controls engine and drive train.

Malfunction Indicator Light (MIL) -- Malfunction Indicator Light (Service Engine

Soon, Check Engine) is a term used for the light on the instrument panel. It is to alert the driver and/or the repair technician that there is a problem with one or more of vehicle's systems and may cause emissions to exceed federal standards. If the MIL illuminates with a steady light, it indicates that a problem has been detected and the vehicle should be serviced as soon as possible. Under certain conditions, the dashboard light will blink or flash. This indicates a severe problem and flashing is intended to discourage vehicle operation. The vehicle onboard diagnostic system cannot turn the MIL off until the necessary repairs are completed or the condition no longer exists.

DTC -- Diagnostic Trouble Codes (DTC) that identifies which section of the emission control system has malfunctioned.

Enabling Criteria -- Also termed Enabling Conditions. They are the vehicle-specific events or conditions that must occur within the engine before the various monitors will set, or run. Some monitors require the vehicle to follow a prescribed "drive cycle" routine as part of the enabling criteria. Drive cycles vary among vehicles and for each monitor in any particular vehicle. Please refer to the vehicle's factory service manual for specific enabling procedures.

OBD II Drive Cycle -- A specific mode of vehicle operation that provides conditions required to set all the readiness monitors applicable to the vehicle to the "ready" condition. The purpose of completing an OBD II drive cycle is to force the vehicle to run its onboard diagnostics. Some form of a drive cycle needs to be performed after DTCs have been erased from the PCM's memory or after the battery has been disconnected. Running through a vehicle's complete drive cycle will "set" the readiness monitors so that future faults can be detected. Drive cycles vary depending on the vehicle and the monitor that needs to be reset. For vehicle specific drive cycle, consult the service manual.

Freeze Frame Data -- When an emissions related fault occurs, the OBD II system not only sets a code but also records a snapshot of the vehicle operating parameters to help in identifying the problem. This set of values is referred to as Freeze Frame Data and may include important engine parameters such as engine RPM, vehicle speed, air flow, engine load, fuel pressure, fuel trim value, engine coolant temperature, ignition timing advance, or closed loop status.

Fuel Trim (FT) - Feedback adjustments to the base fuel schedule. Short-term fuel trim refers to dynamic or instantaneous adjustments. Long-term fuel trim refers to much more gradual adjustments to the fuel calibration schedule than short-term trim adjustments. These long-term adjustments compensate for vehicle differences and gradual changes that occur over time.

3. Product Descriptions

3.1 Outline of FX2000

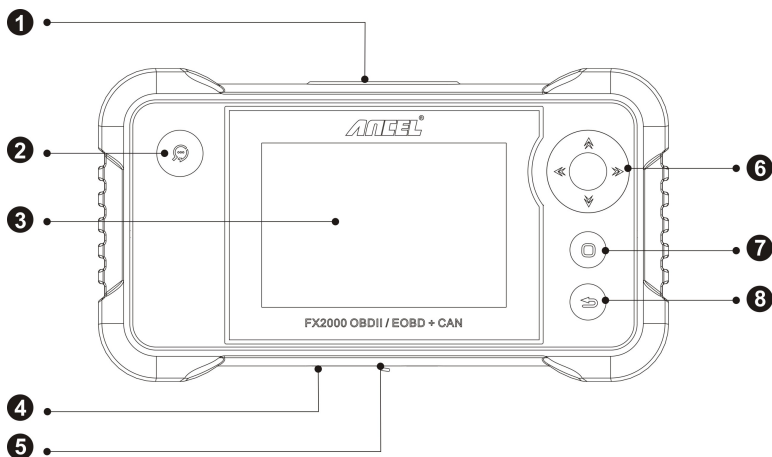

Figure 3-1 FX2000 Front View

No.	Name	Descriptions
1	OBD-16 connector	To connect to vehicle's DLC (Data Link Connector) via diagnostic cable.
2	DTC button	To retrieve the DTCs in the database.
3	LCD	Indicates test results.
4	Memory card slot	Insert the memory card into it to read or write the data/file stored in memory card.
5	USB port	To connect on PC to upload data or print test results.

6	Up/Down	Move cursor up and down for selection.
	Left/Right	Move cursor left or right for selection; Or turn page up and down when more than one page is displayed.
7	OK	Confirms a selection (or action) from a menu list.
8	ESC	Exit the current program or return to the previous screen.

3.2 Specifications

- Screen: 4.0" TFT LCD display
- Input voltage range: 9~18V
- Working temperature: 0 to 50°C (32 to 122 F°)
- Storage temperature: -20 to 70°C (-4 to 158 F°)
- External Dimension: 7.7"(L) x 4.17"(W) x 1.25"(H)
- Weight: <400g

3.3 Accessories Included

1. FX2000 handset
2. Diagnostic cable
3. User manual
4. Memory card
5. Memory card reader
6. USB cable

4. Connection

4.1 Install memory card

- 1) Take out the memory card from package box.
- 2) Insert the memory card into the FX2000 memory card slot perpendicularly. Make sure is fully inserted in the right place with the “micro” label facing upward.

Note: You can hear a clicking sound if you insert the memory card in the right place. Press the card slightly, it will be ejected automatically.

4.2 Connect FX2000

1. Turn the ignition off.
2. Locate vehicle's DLC socket: It provides standard 16 pins and is generally located on driver's side, about 12 inches away from the center of dashboard. See Figure 2-2. If DLC is not equipped under dashboard, a label indicating its position will be given. In case no DLC is found, please refer to Automobile Repair Manual.
3. Plug one end of the diagnostic cable into the OBD II 16 pin connector of FX2000, and connect the other end to the vehicle's DLC.

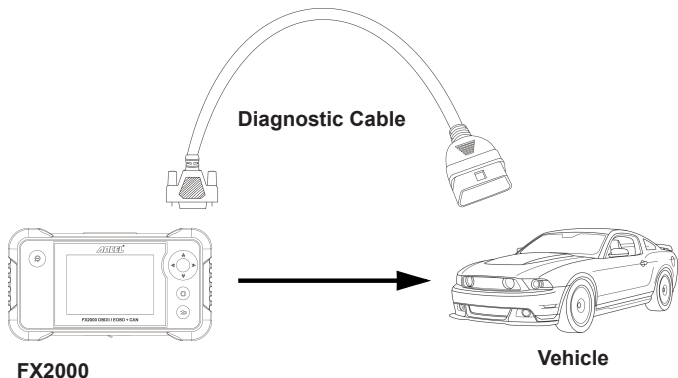

Figure 4-2

4. Turn the ignition on. Engine can be off or running.
5. After finishing, the system will start initializing. After initialization, the system will enter the main menu interface.

CAUTION: Don't connect or disconnect any test equipment with ignition on or engine running.

4.3 Settings

Select [Settings] in the main menu and press [OK], the system will enter the following screen:

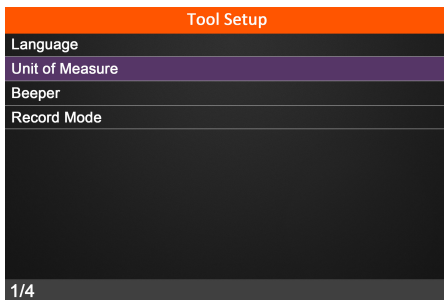

Figure 4-2

1) Language

This option enables you to set the user interface language.

Note: Due to continuous software upgrade, language interface may differ from different software versions.

2) Unit of Measure

This option allows you to set measurement unit.

3) Beeper

It is used to set On/Off the buzzer.

4) Record Mode

It is used to turn On/Off recording function.

5. Diagnose

Select [Diagnose] in Main Menu and press [OK], the screen will display Monitor Status interface as following figure 5-1:

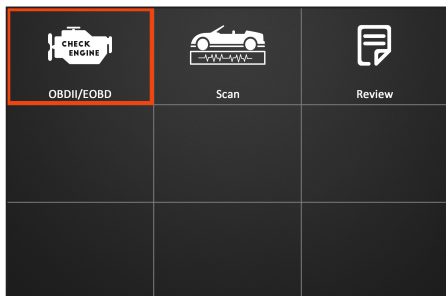

Figure 5-1

5.1 OBDII/EOBD Diagnosing

This option presents a quick way to check for DTCs, isolate the cause of the illuminated Malfunction Indicator Lamp (MIL), check monitor status prior to emissions certification testing, verify repairs, and perform a number of other services that are emission-related.

In Figure 5-1, press [OK] to enter system, the screen will automatically jump to figure 5-2:

Monitor Status	
MIL Status	OFF
DTCs in this ECU	108
Readiness Completed	5
Readiness Not Completed	2
Readiness Not Supported	3
Datastream Supported	119
Ignition	Spark
OK - Confirm	

Figure 5-2

Press [OK], a screen similar to Figure 5-3 will appear:

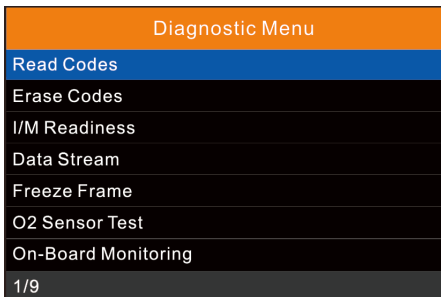

Figure 5-4

It mainly includes the following functions:

Follow the on-screen instructions to check the possible cause and retry it.

1. Read Codes

This option is used to identify which section of the emission control system has malfunctioned.

2. Erase Codes

After reading the retrieved codes from the vehicle and certain repairs have been carried out, you can use this function to erase the codes from the vehicle. Before performing this function, please be sure the vehicle's ignition key is in the ON position with the engine off.

Notes:

- Before performing this function, make sure to retrieve and record the trouble codes.
- After clearing, you should retrieve trouble codes once more or turn ignition on and retrieve codes again. If there are still some trouble codes in the system, please troubleshoot the code using a factory diagnosis guide, then clear the code and recheck.

3. I/M Readiness

I/M refers to Inspection and Maintenance that is legislated by the Government to meet federal clean-air standards. I/M Readiness indicates whether or not the various emissions-related systems on the vehicle are operating properly and are ready for Inspection and Maintenance testing.

The purpose of the I/M Readiness Monitor Status is to indicate which of the vehicle's Monitors have run and completed their diagnosis and testing (as described in Chapter 2.5), and which ones have not yet run and completed testing and diagnosis of their designated sections of the vehicle's emissions system.

The I/M Readiness Monitor Status function also can be used (after repair of a fault has been performed) to confirm that the repair has been performed correctly, and/or to check for Monitor Run Status.

4. Data Stream

This option retrieves and displays live data and parameters from the vehicle's ECU.

5. View Freeze Frame

When an emission-related fault occurs, certain vehicle conditions are recorded by the on-board computer. This information is referred to as freeze frame data. Freeze Data is a snapshot of the operating conditions at the time of an emission-related fault.

Note: If DTCs were erased, Freeze Data may not be stored in vehicle memory depending on vehicle.

6. O2 sensor test

The results of O2 sensor test are not live values but instead the results of the ECU's last O2 sensor test. For live O2 sensor readings, refer to any of the live sensor screens such as Graph Screen.

Not all test values are applicable to all vehicles. Therefore, the list generated will vary depending on vehicle. In addition, not all vehicles support the Oxygen Sensors screen.

7. On-board monitor test

This function can be utilized to read the results of on-board diagnostic monitoring tests for specific components/systems.

8. EVAP System Test

The EVAP test function lets you initiate a leak test for the vehicle's EVAP system. The FX2000 does not perform the leak test, but signals to vehicle's on-board computer to initiate the test. Before using the system test function, refer to the vehicle's service repair manual to determine the procedures necessary to stop the test.

9. Vehicle Info

This option displays the vehicle information, such as VIN (Vehicle Identification Number), CID (Calibration ID) and CVN (Calibration Verification Number).

5.2 System Diagnosing

This function is specially designed to diagnose electronic control system of single vehicle model which includes the following systems:

- ENG (Engine)
- ABS (Anti-lock Brake System)
- TCM (Transmission Control Module)
- SRS (Supplemental Restraint System)

Notes:

- Before diagnosing, please make sure the diagnostic program corresponding to certain vehicle model has been installed on your FX2000.
- For vehicles manufactured by different vendors, it is possible that it has different diagnostic menus. For details, please follow the instructions on the screen to proceed.

Refer to the flowchart illustrated as below to diagnose a vehicle:

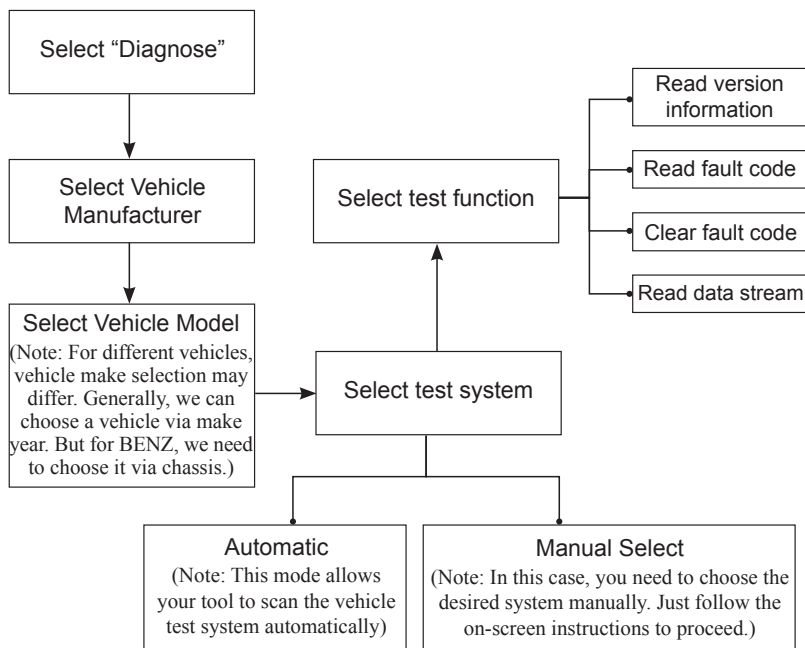

5.3 Review

This function is used to review or delete the recorded DTC, Data Streams and Freeze Frame.

6. Help

This menu enables you to view device information and OBD introduction. In main menu, select [Help] and press [OK] to enter Figure 6-1.

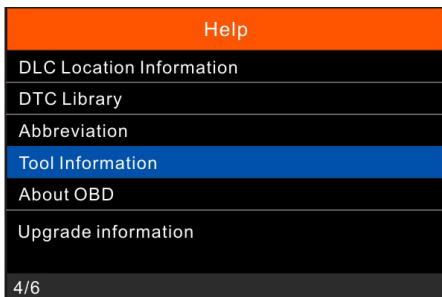

Figure 6-1

6.1 DLC Location Information

This option helps you to find the location of the vehicle's DLC.

6.2 DTC Library

In Figure 6-1, select [DTC Library] and press [OK] to enter the following screen.

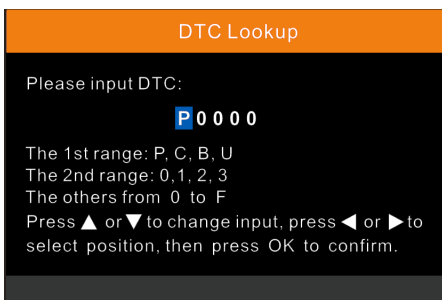

Figure 6-2

Press [◀]/[▶] button to move the highlight bar to different position. Press [▲]/[▼] button to alter the value, then press [OK] button, the screen will display definition of the DTC.

6.3 Abbreviation

This option allows you to view the full name and detailed explanation of the automotive glossary abbreviations.

6.4 Tool Information

In Figure 6-1, select [Tool Information] and press [OK] to view the related information of FX2000.

Tool Information	
Boot version:	V10.04
Display program version:	V02.44
Diagnostic program version:	V11.25
Diagnostic library version:	V11.49
Serial Number:	xxxxxxxxxxxx
Register Code:	270025000247
ESC - Exit	

Figure 6-3

Note: You are strongly recommended to note down the Serial Number and Register Code in Figure 6-3 since these 2 pieces of information are required while registering your FX20000.

Press [ESC] to return to the previous screen.

6.5 About OBD

This option allows you to have a general knowledge of OBD.

6.6 Upgrade Information

This option provides you with a website link to download the update suite.

7. Register & Update

Hardware Requirement:

1. A computer that can access the Internet.
 2. A memory card reader/writer and a memory card that need to be updated.
- There are 2 methods available: via memory card or via USB cable. Here we take memory card for example to demonstrate how to update your tool:
1. Go to <http://www.anceldirect.com> and click "Download" --> "FX2000", then click updating icon.
 2. Download and install the update tool and launch the program when installed.
 3. You will be prompted to type in the Serial Number (located at the back of the tool) (Figure 7-1)

The screenshot shows a software window with a light beige background. It contains two dropdown menus: "Select Language" with "English" selected, and "Product Serial Number" which is currently empty. Below these is a blue button labeled "Device Upgrade".

Figure 7-1

4. After the Serial Number is entered, click [Device Update] and enter the following information. Click [Submit] (Figure 7-2).

The screenshot shows a registration dialog box with a light gray background. It has three text input fields: "Your E-mail address:", "Confirm E-mail:", and "Register Code:". At the bottom, there are three buttons: "Cancel", "Submit", and "Exit".

Figure 7-2

(If you need the Register Code, proceed to the steps 5-8)

(If you have the Register Code, proceed to step 9 directly)

5. The Register Code can be found by connecting the supplied USB cable to the tool and inserted into the computer.
6. When the tool has powered up, place cursor on the Help icon and press the

[OK] button. (Figure 7-3)

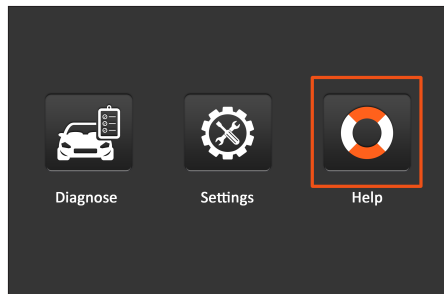

Figure 7-3

7. Select [Tool Information], press [OK]. (Figure 7-4)

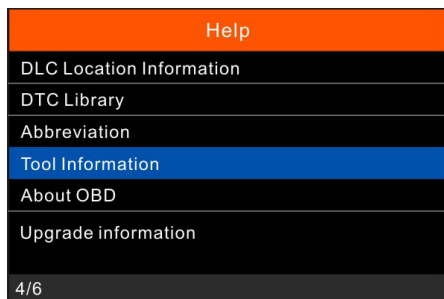

Figure 7-4

8. This is the Register Code number for inputting into step 4 (Figure 7-5).

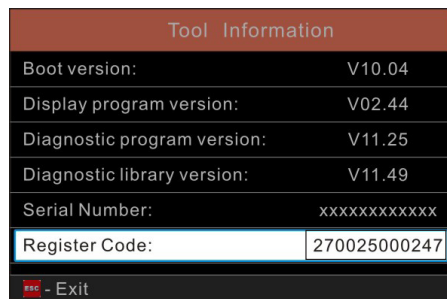

Figure 7-5

(Return to step 4 and input the code and then proceed)

9. Install the memory card from the tool into the supplied card adapter and insert into USB port of CPU.
10. Reopen the FX2000 update Suite and select the updates you would like to perform or click [Select All] and click [Download]. (Figure 7-6)

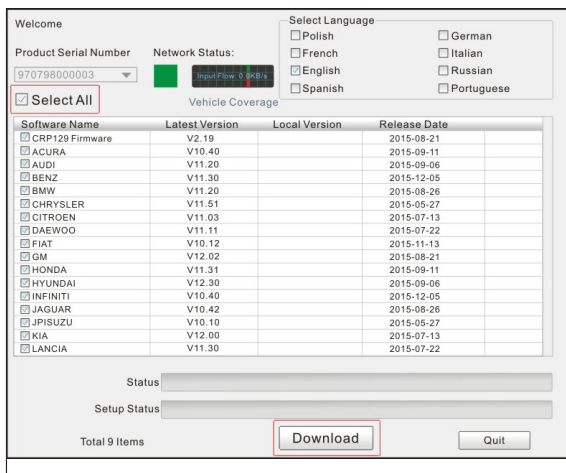

Figure 7-6

11. Once all steps are complete, reinsert the memory card into the tool and power the tool via USB in computer or via OBD2 port in vehicle. The tool will prompt you to upgrade, click [OK] to start updating and a progress bar will appear. It may take several minutes to finish update if your upgrade package file is too large, please wait. (Figure 7-7)

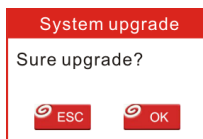

Figure 7-7

12. The registration process is now complete!

8. FAQ

Here we list some frequently asked questions and answers relating to FX2000.

Question: System halts when reading data stream. What is the reason?

Answer: It may be caused by a slackened connector. Please turn off the FX2000, firmly connect the connector, and switch it on again.

Question: Screen of main unit flashes at engine ignition start.

Answer: Caused by electromagnetic disturbing, and this is normal phenomenon.

Question: There is no response when communicating with on-board computer.

Answer: Please confirm the proper voltage of power supply and check if the throttle has been closed, the transmission is in the neutral position, and the coolant is in proper temperature.

Question: Why are there so many fault codes?

Answer: Usually, it's caused by poor connection or fault circuit grounding.

Warranty

THIS WARRANTY IS EXPRESSLY LIMITED TO PERSONS WHO PURCHASE ANCEL PRODUCTS FOR PURPOSES OF RESALE OR USE IN THE ORDINARY COURSE OF THE BUYER'S BUSINESS.

ANCEL electronic product is warranted against defects in materials and workmanship for one year (12 months) from date of delivery to the user.

This warranty does not cover any part that has been abused, altered, used for a purpose other than for which it was intended, or used in a manner inconsistent with instructions regarding use. The exclusive remedy for any automotive meter found to be defective is repair or replacement, and ANCEL shall not be liable for any consequential or incidental damages.

Final determination of defects shall be made by ANCEL in accordance with procedures established by ANCEL. No agent, employee, or representative of ANCEL has any authority to bind ANCEL to any affirmation, representation, or warranty concerning ANCEL automotive meters, except as stated herein.

Order Information

Replaceable and optional parts can be ordered directly from your ANCEL authorized tool supplier. Your order should include the following information:

1. Quantity
2. Part number
3. Item description

Customer Service

If you have any questions on the operation of the unit, please contact local dealer, or contact OBDSpace Technology, Co., Ltd.:

Tel: 86-755-81751202

E-mail: sales@anceldirect.com

Statement: ANCEL reserves the rights to make any change to product designs and specifications without notice. The actual object may differ a little from the descriptions in the manual in physical appearance, color and configuration. We have tried our best to make the descriptions and illustrations in the manual as accurate as possible, and defects are inevitable, if you have any question, please contact local dealer or after-sale service center of ANCEL, ANCEL does not bear any responsibility arising from misunderstandings.