



User's Manual

Model:V6 www.anceltech.com



Table of Contents

1 Statement.....	1
1.1 Agreement.....	1
1.2 Copyright information.....	1
1.3 Disclaimer.....	2
1.4 Safety Information.....	2
1.4.1 Inspection Precautions.....	3
2 Product description.....	6
2.1 Product Overview.....	6
2.2 The front view of Ancel V6 tablet.....	7
2.3 The top view of Ancel V6 tablet.....	8
2.4 The back view of Ancel V6 tablet.....	9
2.5 The product specifications.....	9
3 Product software introduction.....	11
3.1 Diagnosis.....	11
3.2 Hot function.....	15
3.3 Update.....	15
3.4 Data Manager.....	17
3.5 Quick Support.....	17
3.6 DTC Query.....	18
3.7 Feedback.....	19
3.8 Settings.....	20
4 Product activation.....	24
5 Cleaning and maintenance and warranty.....	26
5.1 Cleaning and maintenance.....	26
5.2 Warranty.....	27

1 Statement

You must carefully read the instruction manual, especially the safety instructions, before you can connect, commission and operate the products of OBDSpace Technology Co., Ltd., Ltd. (hereinafter referred to as “OBDSpace”).

1.1 Agreement

Once the product is used, it is an endorsement of the following:

- (1) Please refer to the packing list of the random distribution for the configuration equipment of this product, whichever is the actual product;
- (2) The functions and pictures described in this manual are subject to the actual software. All information, specifications and illustrations in the manual are the latest information at the time of publication. The company reserves the right to change it without notice.

1.2 Copyright information

It cannot be copied or stored in any form (electronic, mechanical, photocopying, recording or otherwise) without prior written permission being secured from OBDSpace. Software and data are owned by technology and protected by copyright laws, international

contract law, and other national laws. It is strictly forbidden to copy or transfer the data and software or some of the contents. If there is any violation, the technology will be held legally responsible according to law.

1.3 Disclaimer

(1) This manual only provides the operation and operation methods for Ancel V6. The company does not assume any responsibility for the consequences caused by using the operation methods for other equipment operations.

(2) The company shall not accept any responsibility for accidents caused either by the user personally or anyone else, or costs and expenses due to equipment damages including equipment loss caused by the user's abuse or misuse, arbitrary changes or repairs or operation of the equipment in a manner not in accordance with the manual requirements.

1.4 Safety Information

For the safety of yourself and others, and to avoid damage to equipment and vehicles, all personnel handling the equipment must read the safety precautions mentioned in the manual.

1.4.1 Inspection Precautions

(1) Ancel V6 can only be connected to a safety outlet that is grounded. Before connecting, check and confirm that the diagnostic circuit is in good condition. Otherwise, it is not necessary to test to avoid damage to the main unit. If necessary, use a multimeter to measure the diagnostic seat voltage.

(2) Use only the power cord supplied with the OBDSpace diagnostics or detected power line.

(3) Pay special attention to the effects or damage caused by environmental factors such as acid and alkali, poison gas, and heavy pressure.

(4) Exhaust gases from the engine contain a variety of toxic compounds and should be avoided. Park the vehicle in a well ventilated area before operation.

(5) Do not place the device on the vehicle's power distribution unit. Strong electromagnetic interference can cause damage to the equipment.

(6) After the equipment is installed successfully, before starting the engine, make sure that the parking brake is pulled and the speed lever is placed in the neutral or parked position to avoid accidents when the vehicle is started.

(7) When the engine is running at a high temperature, avoid

contact with high temperature components such as the water tank and the exhaust pipe. At the same time, be careful of the voltage generated by the components such as the ignition coil, the distributor cover, the ignition circuit and the ignition plug during engine operation.

1.4.2 Notes on the use of the instrument

(1) This instrument is a precision electronic instrument. Do not drop it. Handle it as gently as possible, away from heat and electromagnetic fields.

(2) Ensure that the instrument and diagnostics are well connected so that signal interruptions do not affect the test.

(3) Use screws as much as possible when using the cables and connectors to avoid disconnecting and damaging the connectors when moving. Hold the front end of the connector when pulling the connector, and avoid pulling the rear cable to avoid damage to the diagnostic interface.

(4) When the electrical components are energized, the circuit cannot be disconnected to prevent self-inductance, mutual inductance and current sensors and the vehicle ECU.

(5) The operation of this instrument requires a certain basis for vehicle inspection and maintenance, and has a certain understanding of the electronic control system of the vehicle under test.

1.4.3 Operating car ECU considerations

When performing diagnostic operations on a vehicle equipped with a computer control system, the following should be noted:

(1) Do not place magnetic objects such as radio speakers close to the computer, as the magnetic properties of the speakers can damage the circuits and components in the ECU.

(2) When the ignition switch is turned on, the internal electrical equipment of the car must not be disconnected. Due to the self-inductance of the coil when disconnected, a high instantaneous voltage will be generated, which will cause damage to the sensor and ECU;

(3) When performing repairs near a computer or sensor, special care should be taken to avoid damage to the ECU and sensor;

(4) When carrying out maintenance work on or near the ECU-controlled digital meter, be sure to wear a metal strap with one end clamped to the body and the other end wrapped around the wrist;

(5) When performing welding work on a car, the ECU system power should be turned off beforehand;

(6) Do not use test lights to test ECU-related electrical devices to prevent damage to the ECU or sensor unless specifically stated;

(7) Test ECU and sensors cannot be tested with a pointer-type ohmmeter, unless otherwise specified in the test procedure, but should be tested with a high-impedance digital meter.

2 Product description

2.1 Product Overview

Ancel V6 is a professional efficient and convenient diagnostic tool for passenger car.

- Powerful quad-core Cortex-A53 2.0GHz processor with faster 2GB LPDDR4 and reliable 32GB On-board memory
- Android 10.0 OS running on 8.0 inch IPS Multi-touch capacitive touch screen
- Unique ergonomic design with rubberized outer protection and a rugged internal housing
- Built-in rechargeable lithium-polymer battery for up to 10 hours of continuous operation
- OE-Level full-systems coverage for more than 80 vehicle makes
- Supporting 15 most commonly used service Reset Functions, more to cover soon
- Remote Technical Support via Teamviewer

2.2 The front view of Ancel V6 tablet

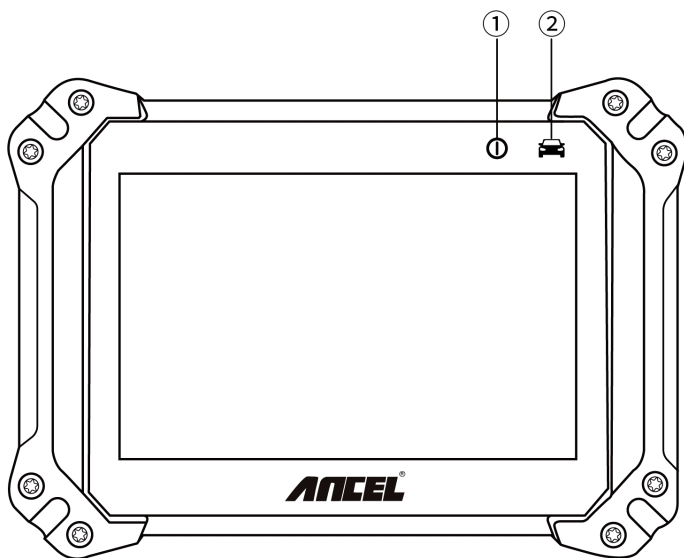

No.	Name	Description
①	Power Indicator	Lights on green when power on and the battery is higher than 20% Lights on red when power on and the battery is lower than 20% Lights on blue when it is charging Lights on green when it is full charge
②	Communication Indicator	The light flashing when diagnose communication

2.3 The top view of Ancel V6 tablet

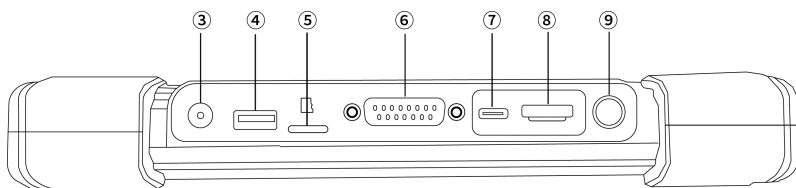

No.	Name	Description
③	DC Port	DC power supply input port
④	USB Port	USB Port
⑤	TF Port	TF card port, Up to 32GB expand
⑥	OBD Port	OBDII main cable connector
⑦	Type-C Port	Type-C port
⑧	HDMI Port	High-Definition multimedia interface port
⑨	Start Button	The button turn ON/OFF the system

2.4 The back view of Ancel V6 tablet

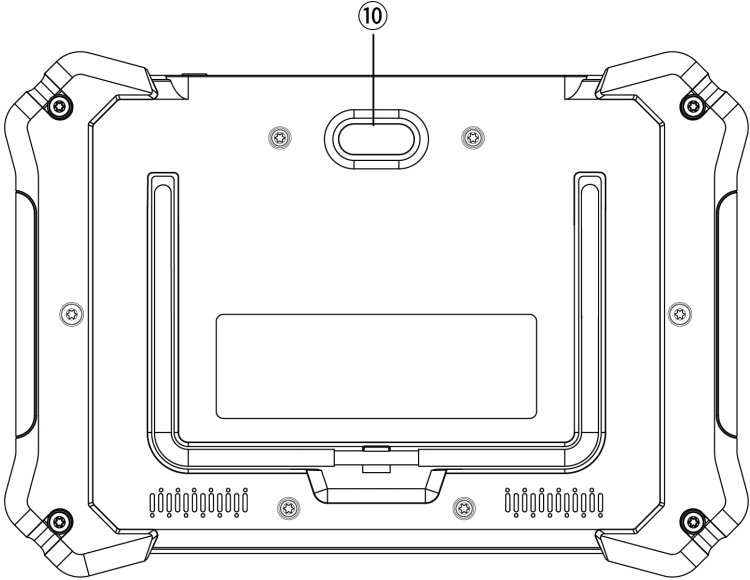

No.	Name	Description
⑩	Camera	Camera lens and camera flash

2.5 The product specifications

Item	Description
CPU	Quad-core Cortex-A53 2.0GHz

GPU	G52 3EE MC1@800MHz
Operaton system	Android 10. 0
ROM	32 GB EMMC
RAM	2G LPDDR4
Display	8.0 inch IPS Multi-touch Capacitive Touch Screen with 800*1280 resolution
Camera(rear)	5.0 Megapixel, AF with Flashlight
Connectivity	WIFI: 802.11 b/g/n/ac Support Hot spot/ 2.4/5GHz Bluetooth: 5.0: USB 2.0 Type-C HDMI: 1080P Output TF Card (Support up to 32GB)
Audio	Microphone Dual Speakers
Power and Battery	8000 mAh 3.7 V lithium-polymer battery
Input Voltage	8V – 30V
Power Consumption	6.5 W
Operating Temp.	-10 to 50°C (14 to 122°F)
Storage Temp.	-20 to 60°C (-4 to 140°F)
Dimensions(WxHxD)	270 mm(10.63 in) x 193 mm(7.60 in) x 38 mm(1.50 in)
Weight	NW: 1.20 kg (2.65 lb) GW: 3.00 kg (6.61 lb)
Protocols	ISO 9141-2, ISO 14230-2, ISO 15765-4, K/L-Line, SAE-J1850 VPW, SAE-J1850 PWM, CAN ISO 11898,

	Highspeed, Middlespeed, Lowspeed and Singlespeed CAN, GM UART, UART Echo Byte Protocol, Honda Diag-H Protocol, TP2.0, TP1.6, SAE J1939, SAE J1708, Fault-Tolerant CAN etc.
--	--

3 Product software introduction

The software homepage show the functional module: Diagnosis, Hot Function, Quick Support, DTC Query, Update, Data Manager, Feedback, Settings.

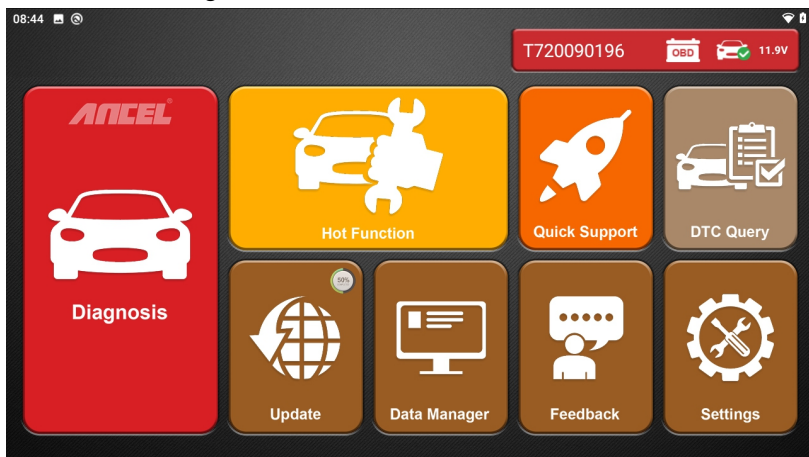









3.1 Diagnosis











Extensive vehicle coverage for more than 80 Europe, America, Asia,

China and Australia vehicle makes.













DIAGNOSE HOT FUNC OBD II 11.8V

EUROPE	 ABARTH	 ALFA ROMEO	 ASTON	 AUDI
AMERICA				
ASIA				
CHINA	 BENTLEY	 BUGATTI	 BENZ	 BMW
AUSTRALIA				
	 CITROEN	 DACIA	 FERRARI	 FIAT













DIAGNOSE HOT FUNC OBD II 11.8V

EUROPE				
AMERICA	 GM	 BUICK	 CADILLAC	 CHEVROLET
ASIA				
CHINA				
AUSTRALIA	 GMC	 RAVON	 CHRYSLER	 FORD(AMERICA)
	 JEEP	 SCION	 DODGE	

DIAGNOSE HOT FUNC OBD II 11.8V

EUROPE	 HYUNDAI	 ACURA	 DAEWOO	 DAIHATSU
AMERICA				
ASIA				
CHINA	 FUSO	 HONDA	 INFINITI	 ISUZU
AUSTRALIA				
	 KIA	 LEXUS	 LUXGEN	 MAZDA

DIAGNOSE HOT FUNC OBD II 11.8V

EUROPE	 BYD	 CHANGAN	 CHANGHE	 CHERY
AMERICA				
ASIA				
CHINA	 EMGRAND	 ENGLON	 FOTON	 GEELY
AUSTRALIA				
	 GLEAGLE	 GWM	 HBSH	 HUACHEN

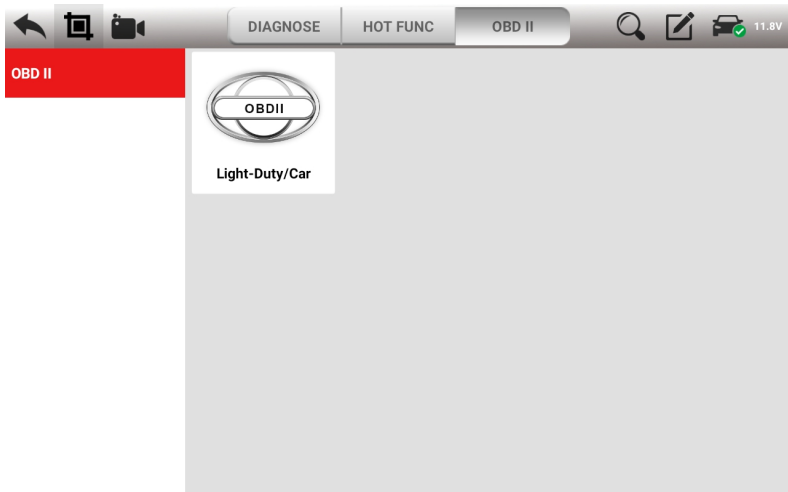
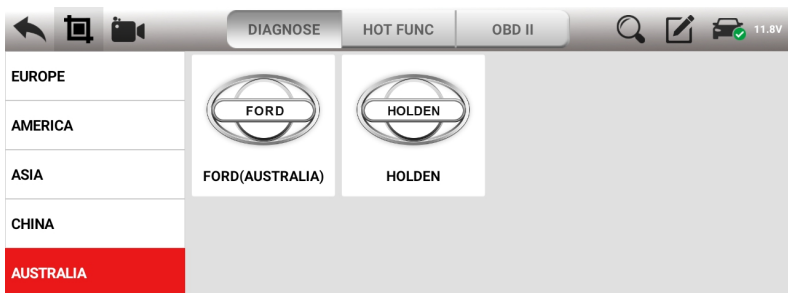

3.2 Hot function

Supporting 15 most commonly used service Reset Functions: OILREST, ABS BLEEDING, BATTERY, DPF, EPB, INJECTOR, SAS, THROTTLE, TPMS, IMMOKEYS, AT SET, GEAR, HEADLIGHT, SUSPENSION, SUNPROOF.

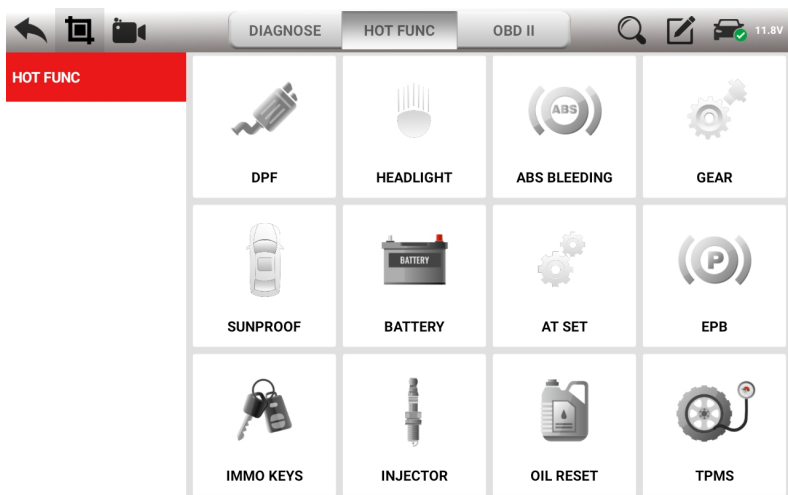

3.3 Update

Logging in the Update function, you can download the vehicle data and service function data, you can select all and one-click upgrade.

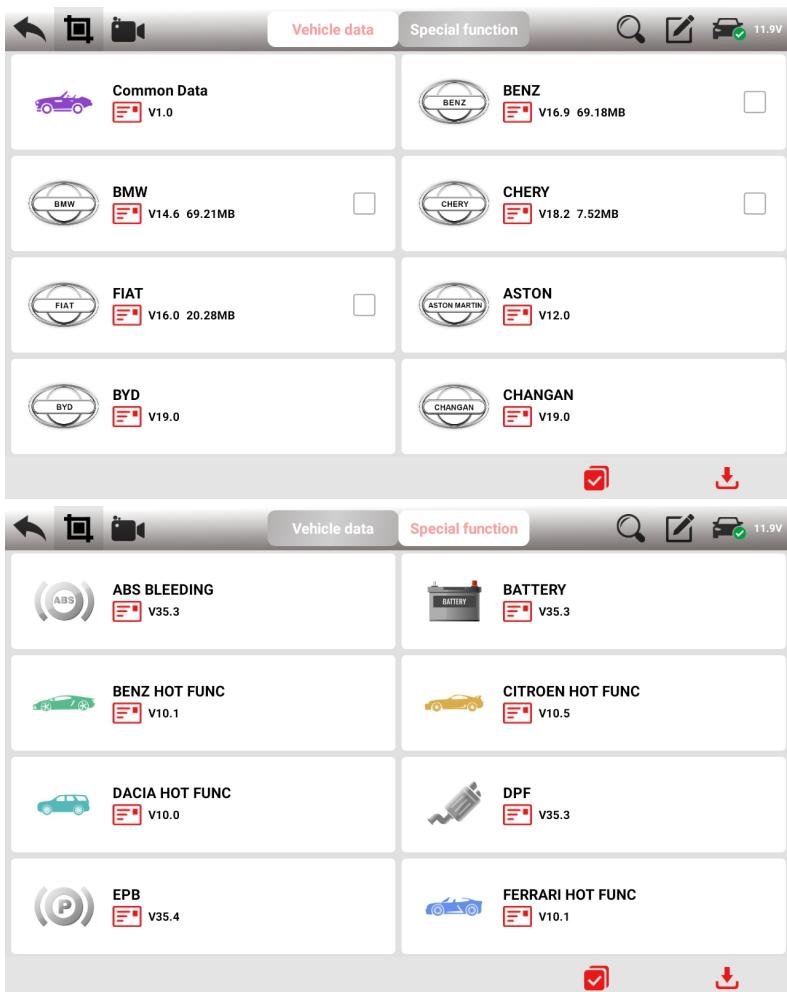

3.4 Data Manager

Here can manage the screenshot pictures, record video, vehicle software, testing report, data playback and function list.

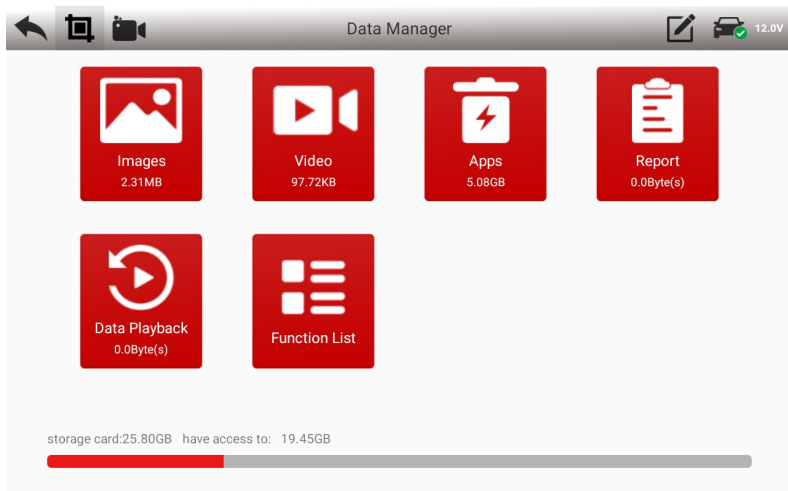

3.5 Quick Support

Remote technical support via Teamviewer QuickSupport.

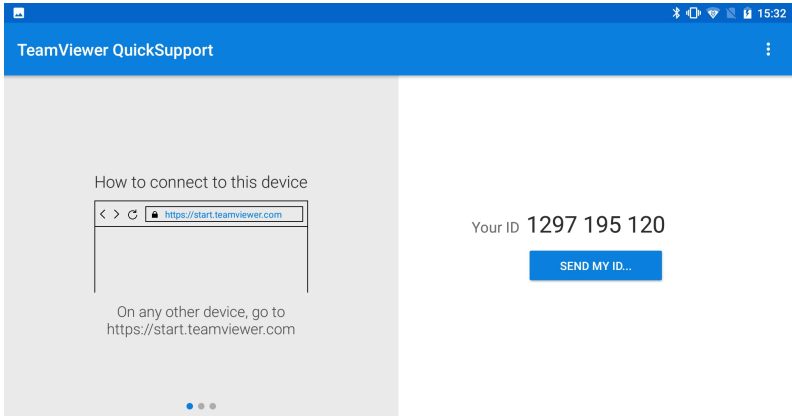

● Ready to connect (secure connection)

3.6 DTC Query

The fault information corresponding to the fault code can be quickly retrieved to help the repairer locate the component fault.

Fault Code	Vehicle Model	Fault Description
P0001	GENERAL	Fuel Volume Regulator Control Circuit/Open
P0002	GENERAL	Fuel Volume Regulator Control Circuit Range/Performance
P0003	GENERAL	Fuel Volume Regulator Control Circuit Low
P0004	GENERAL	Fuel Volume Regulator Control Circuit High
P0005	GENERAL	Fuel Shutoff Valve "A" Control Circuit/Open
P0006	GENERAL	Fuel Shutoff Valve "A" Control Circuit Low
P0007	GENERAL	Fuel Shutoff Valve "A" Control Circuit High

3.7 Feedback

This function allows you upload vehicle diagnostics problems encountered by users during the use of the software. It can help engineers repair software errors quickly.

Feedback

Vehicle Name: 

Question Type 

* Complaint Content:

Attachments 

Submit

3.8 Settings

View or set the Run mode, unit, search engine, System Info, Version Update, Languages.

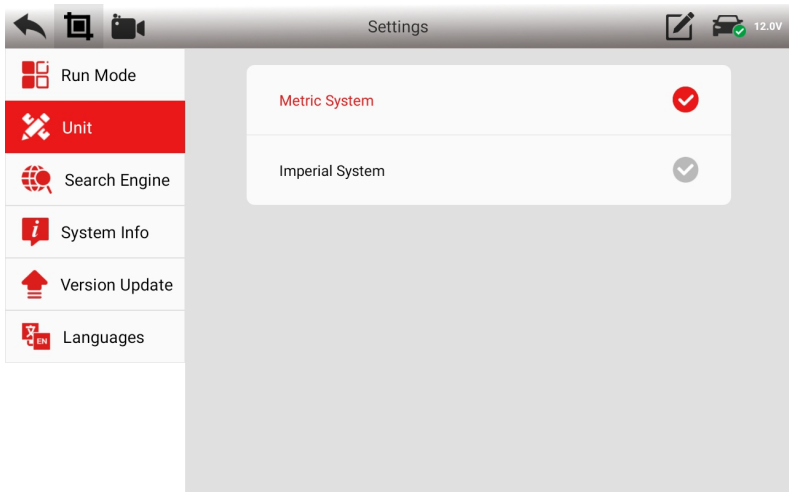
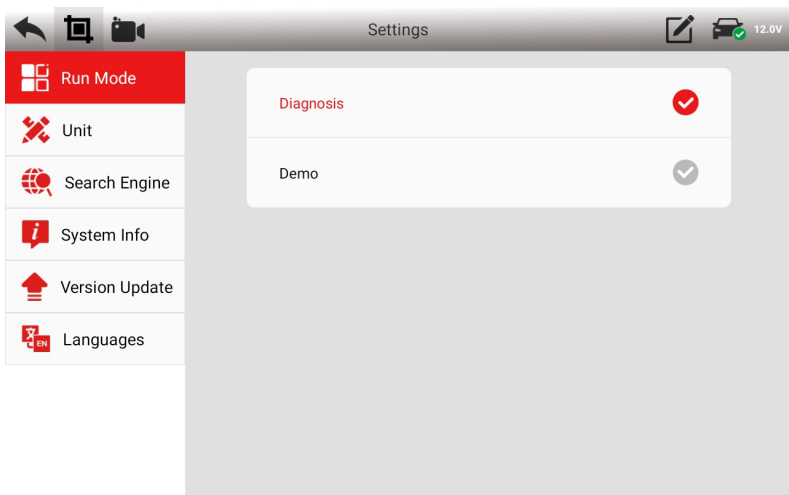

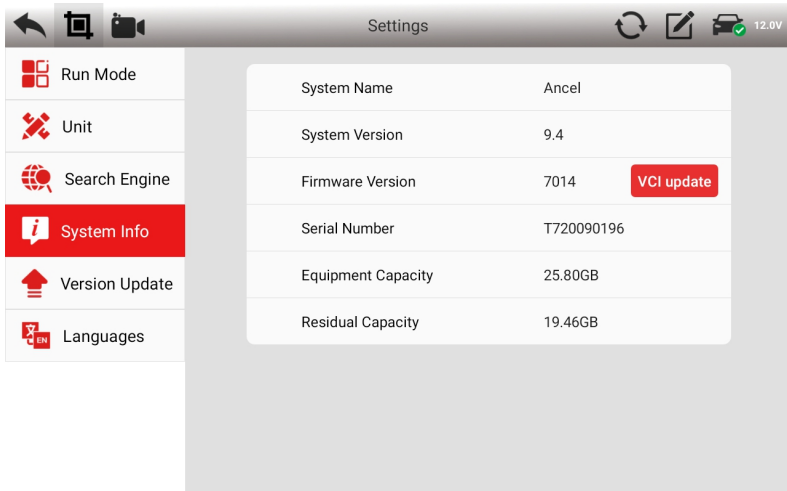
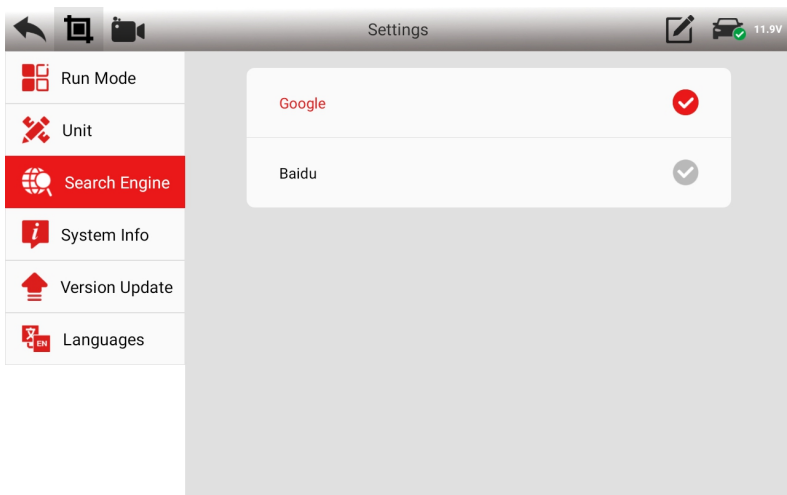

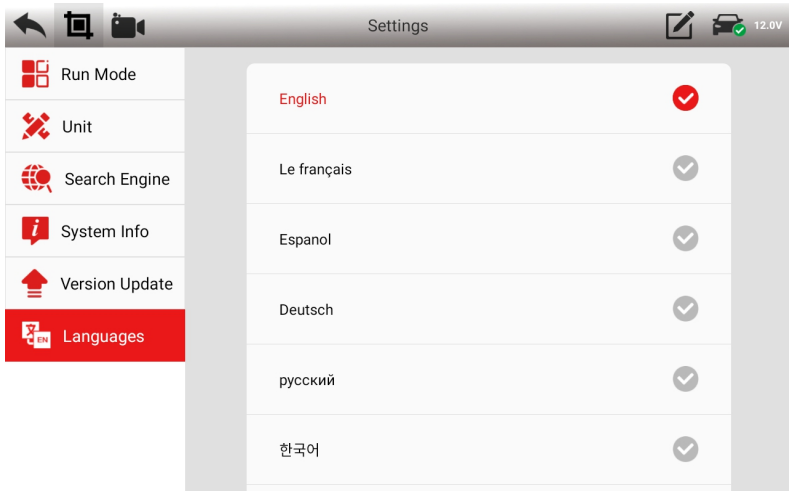
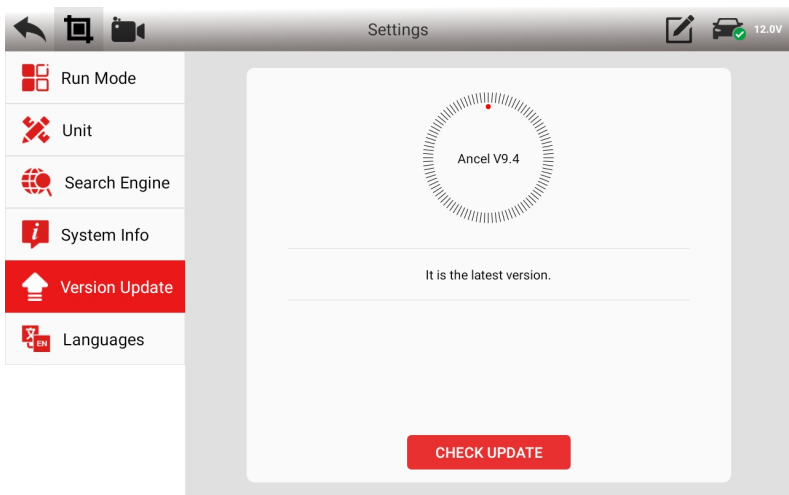

4 Product activation

(1) Click the Update function on the home page

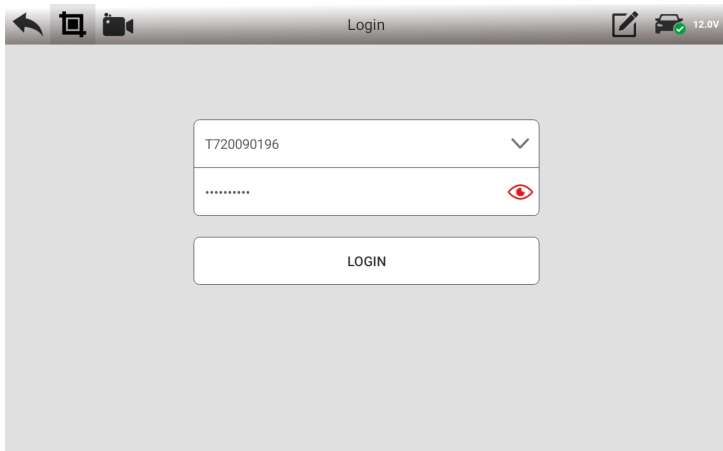
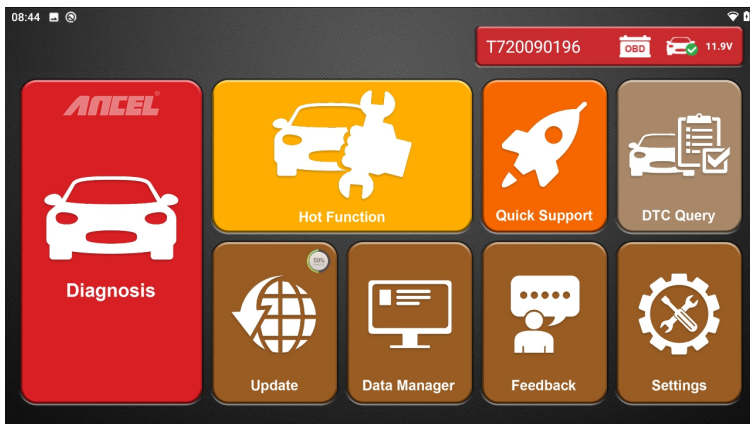

(2) Please activate the product in the first login

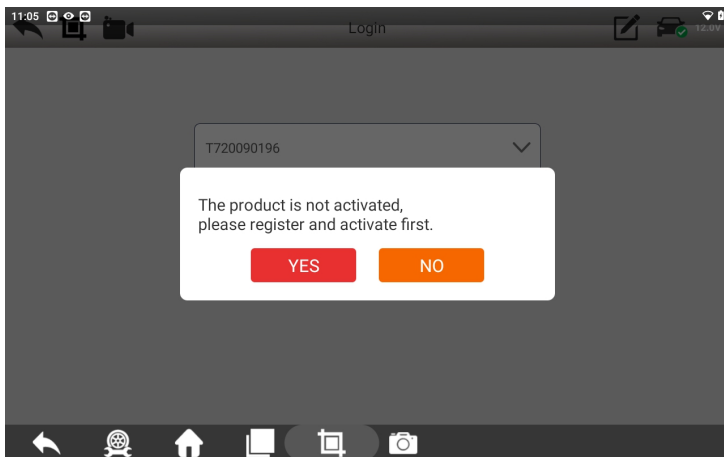

(3) Fill in the activation information, and click ACTIVATION

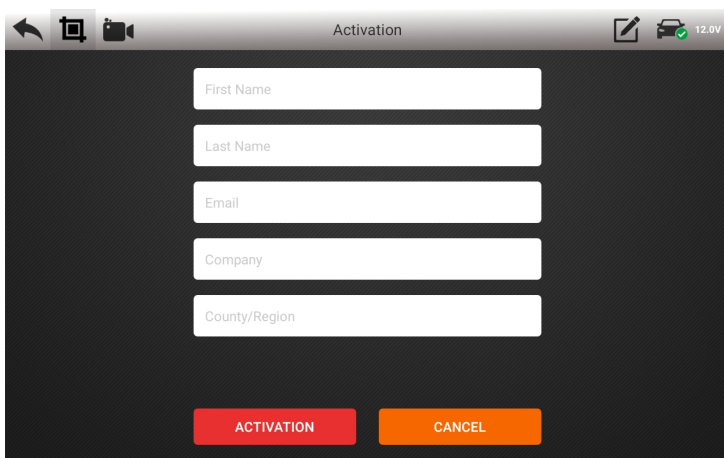

- (4) The activation request sent, your mailbox has received the activation link.

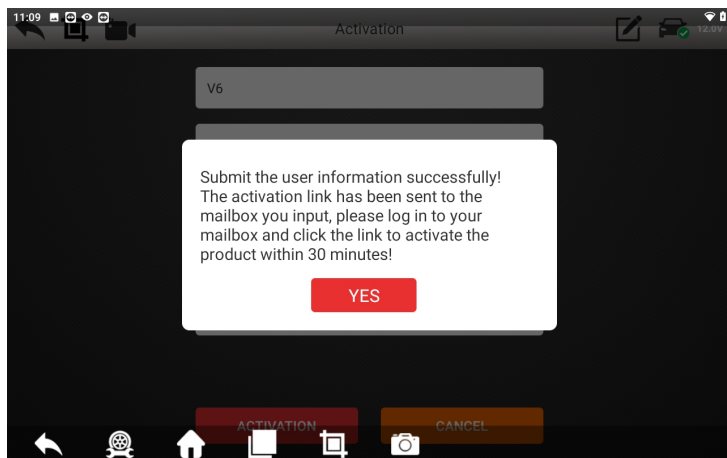

- (5) Log in to the mailbox where you just filled in the activation information and click the activation link to complete the activation.

5 Cleaning and maintenance and warranty

5.1 Cleaning and maintenance

- (1) Do not disassemble it, try to handle it gently to avoid impact.
- (2) Place the fault diagnosis device in a flat, dry,

temperature-friendly and dust-free place and avoid high temperature and humidity, excessive smoke, easy vibration, direct sunlight, and strong magnetic field storage environment.

(3) If the vehicle test operation is not performed for a long time, please run the main machine regularly to avoid moisture.

(4) Unplug the power plug when not in use to avoid aging of electrical components caused by long-term power.

(5) When the host is dirty, please disconnect the power before cleaning.

(6) Do not use a cleaning agent with a corrosive function or any rough cloth to clean the main unit. Only use a soft cloth and a neutral detergent.

(7) The surface of the screen can be cleaned with a special wiper for the LCD screen.

(8) Do not place anything on the screen to avoid cracking of the screen or damage to internal components.

5.2 Warranty

This applies only to products purchased from a product dealer that has been authorized by OBDSpace. If products are purchased from anyone other than a OBDSpace authorized product dealer, buyers will be solely responsible for the cost of product

maintenance services and will not be eligible to obtain any warranty from OBDSpace .

(1) Product acceptance

When you receive the product, please be sure to open the package check.

Please carefully check the product category and quantity according to the attached list. If there are any shortages, errors, damages and other unpredictable abnormal conditions, please keep all the documents of the product and notify us immediately. Otherwise it is considered a waiver of the claim.

(2) Product warranty

Beginning on the date of purchase(subject to valid purchase proof and effective warranty card of the product), if the product suffers performance failure within one month which is not caused by deviation from the recommended operation or by uncontrollable environmental events, you can choose to have evaluation via our maintenance service or replacement of the product with the same model. After that, there is one year warranty service for the main unit, connectors and power adapter.

(3) Product Software Update

Two-year free software update since activation of product, and will be charged annually after free update session.

(4) Not in the scope of the free warranty

A. Failures, defects or flaws not directly related to the quality of the OBDSpace products, including but not limited to failing to use the product according to the user manual's instructions, crash, fall, disassemble by anyone other than a OBDSpace approved service person, connecting improper accessories, damage owing to impact because of improper transport or storage of the product, etc.

B. Natural wear and tear of the product: including but not limited to cover, keypad, touch screen, accessories, etc.

C. Main unit serial number and warranty card serial number discrepancy, product quality inspection tag or bar code removed, altered or damaged.

D. Maintenance and modification without the approval of OBDSpace or its distributors.

(5) Product warranty program

When the product needs to be repaired, please send the product to the local distributor or OBDSpace, and attach the purchase certificate and warranty card, fill in the following information: company name, contact name, phone number, problem description, purchase invoice.

Note: The valid purchase certificate is an important warranty service certificate. To protect your legal rights, you must obtain a

formal invoice from the dealer when purchasing the machine. The name, model number, serial number and purchase date of the product should be clearly stated on the invoice. It is covered with the official seal of the dealer.

(6) Over-warranty product maintenance regulations

If the product needs to be repaired by our company after the maintenance period, we will charge the maintenance fee appropriately, and the freight will be borne by the user.

For products that have passed the warranty period, our technical support personnel will fax the maintenance cost to the user, and will repair it after confirmation by the customer. After confirming, the customer will pay the repair fee to the designated account of our company. After the maintenance fee is received, our company will Can be repaired.

OBDSpace TECHNOLOGY CO.,LTD

D03, Block A, No.973 Minzhi Ave, Longhua District.
Shenzhen, Guangdong, China
Email: support@anceltech.com
Web: www.anceltech.com